

2 ޖަދުވަލު

3 (މިސްޓަރ) ގަރުދާ ޖަދުވަލު ގަވާއިދު ޖަދުވަލު ޖަދުވަލު ޖަދުވަލު

ޖަދުވަލު ޖަދުވަލު ޖަދުވަލު ޖަދުވަލު ޖަދުވަލު				
ގަރުދާ ޖަދުވަލު ގަރުދާ ޖަދުވަލު (ޖަދުވަލު ޖަދުވަލު)	ގަރުދާ ޖަދުވަލު ގަރުދާ ޖަދުވަލު	ގަރުދާ ޖަދުވަލު ގަރުދާ ޖަދުވަލު	ގަރުދާ ޖަދުވަލު ގަރުދާ ޖަދުވަލު	#
				1
				2
				3
				4
				5
ޖަދުވަލު				



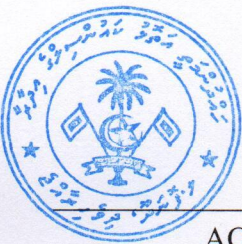

ދިވެހިސަރުކާރުގެ ގެޒެޓް

ސަރުކާރުގެ ގެޒެޓް ގައި ބަޔާންކޮށްފައިވާ ގަވާއިދު			
ނަންބަރު	ޖަދުވަލުގެ ނަންބަރު	ޖަދުވަލުގެ ނަންބަރު	#
			1
			2
			3
		ދިވެހި	

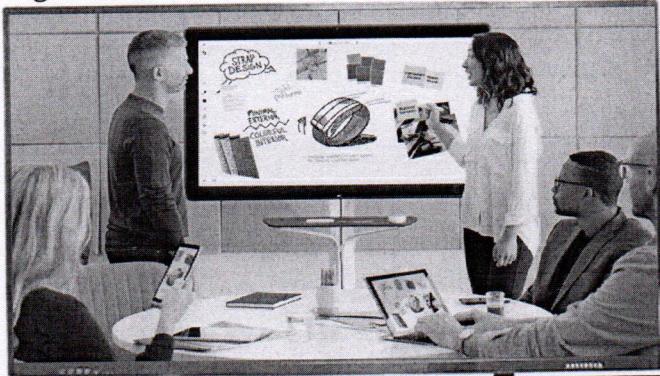

උපකරණ මාරු කිරීමේ කොමසාරිස් කාර්යාලය

නම:	
01	රැකුණු
මාරු කිරීමේ කොමසාරිස් කාර්යාලය:	
<ol style="list-style-type: none"> 1. Name: Interactive whiteboard panel all in one 2. Display: 86inch with OPS with anti-grated screen 3. Operating system: Windows with android 4. Processor of OPS : i3 4Gen 4GRAM+128G SSD android: RAM 2G+32G 5. Resolution of screen: 3840*2160 4K 6. Touch Method: 10-point touch 、 Finger or touch pen 7. Touch pen : 1 pc 8. Connectors: HDMI, USB, VGA, CVB 9. Spect ratio ; 16:9 10. Viewing Angle : 178° 11. Glass: 4mm 12. Power: AC: 100-240V 60/50HZ 13. Operating power: 238W 14. Standby power :<=5W 15. Speaker: 15W*2pcs. 16. Service life: 50000H 17. Images: jpeg, bmp (excluding 32-bit), png, gif, tiff 18. Video: 3gp, 3gpp, asf, avi, divx, flv, mkv, mov, mp4, m4v, mp4v, mpv4, mpeg, mpg, mpeg4, rm, rv, vob, wmv 19. Office formats: doc, docx, ppt, pptx, pdf 20. Including wall bracket 	
	

නම:	
40	රැකුණු
මාරු කිරීමේ කොමසාරිස් කාර්යාලය:	
BANQUET CHAIR Color RED	
	

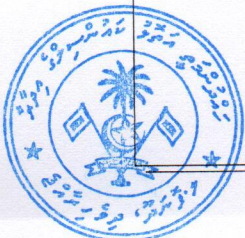

: 000	
17	: 000
1.5x4 000	: 000
Metal Conference Table with Foot Thick Metal Frame Folding Training Table	: 000
	

: 000	
01	: 000
Acer, Dell, Logitech	: 000

: 000	
01	: 000

: 000	
01	: 000
8th Generation Intel core i7 Processor 16GB RAM 128GB SSD Backlite Keyboard	: 000
Acer, Dell, HP, ASUS	: 000

: 000	
01	: 000
Consisting of 2x passive 2-way boxes and 10-channel power mixers Power mixers and speaker cables can be stored in the boxes for transportation Including 2 speaker cables, each 6 m long	: 000
	: 000
Features of the 10-channel power mixer: Power: 2 x 340 W Wireless Audio (Bluetooth) 3-Band EQ Speaker stand SPSX2B (01 pair) ADJ	: 000

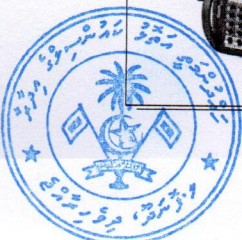

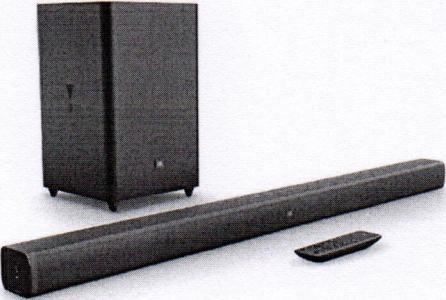
	<p><u>Features of mini sound bar:</u></p> <p><u>Midrange Drivers</u> 4 x 2.3" / 57.2 mm Oval Cone</p> <p><u>High-Frequency Drivers</u> 2 x 1.3" / 31.8 mm Tweeter</p> <p><u>Amplifier Output</u> 300 W Peak</p> <p><u>Frequency Response</u> 40 Hz to 20 kHz</p> <p><u>Maximum SPL</u> 99 dB</p> <p><u>Subwoofer</u> Drivers</p> <p><u>Connectivity</u></p> <p><u>Input</u> 1 x HDMI 1 x Optical TOSLINK 1 x 1/8" (3.5 mm) - Audio</p> <p><u>Output</u> 1 x HDMI</p> <p><u>USB Ports</u> 1 x USB (Version Unspecified)</p> <p><u>Bluetooth</u> 4.2</p>	
---	---	--

<p align="center"><u>Features of Wireless Microphone System</u></p> <p align="center">UHF Band Receiver System Broad Frequency Response Range & Low Distortion Up to 175' Feet Wireless Communication Range Integrated Noise Filtration System High Signal/Noise Ratio Performance Microphone system to Mixer connection cable (6 Meter) x 2</p> 		
--	--	--

<p align="right">ދިވެހިރާއްޖޭގެ ޖުމްހޫރިއްޔާ ގުޅިގެން</p>		
<p align="right">01</p>	<p align="right">ފޮޓޯ ނަންބަރު</p>	

